

User Manual

2KVA-3KVA INVERTER

Table Of Contents

1. Introduction	1
Features.....	1
2. Product Overview	1
3. Safety Instructions.....	2
4. Installation	3
Battery Connection	4
AC Output Connection.....	5
5. OPERATION	5
Power ON/OFF	5
Operation and Display Panel	5
LCD Display Icons	6
LCD Setting.....	8
Display Setting	9
Operating Mode Description	10
Fault Reference Code.....	10
Warning Indicator.....	11
6. SPECIFICATIONS.....	12
7. TROUBLE SHOOTING	13
Appendix: Approximate Back-up Time Table	14

1. Introduction

This inverter can offer uninterruptible power support with portable size. Its comprehensive LCD display offers user-configurable and easy-accessible button operation based on different applications.

Features

- Pure sine wave inverter
- Isolation design between input and output for safety guarantee
- Light weight and anodised aluminum casing
- Low power consumption for energy saving
- Overload/ DC reverse/ Over temperature/ short circuit protection

2. Product Overview

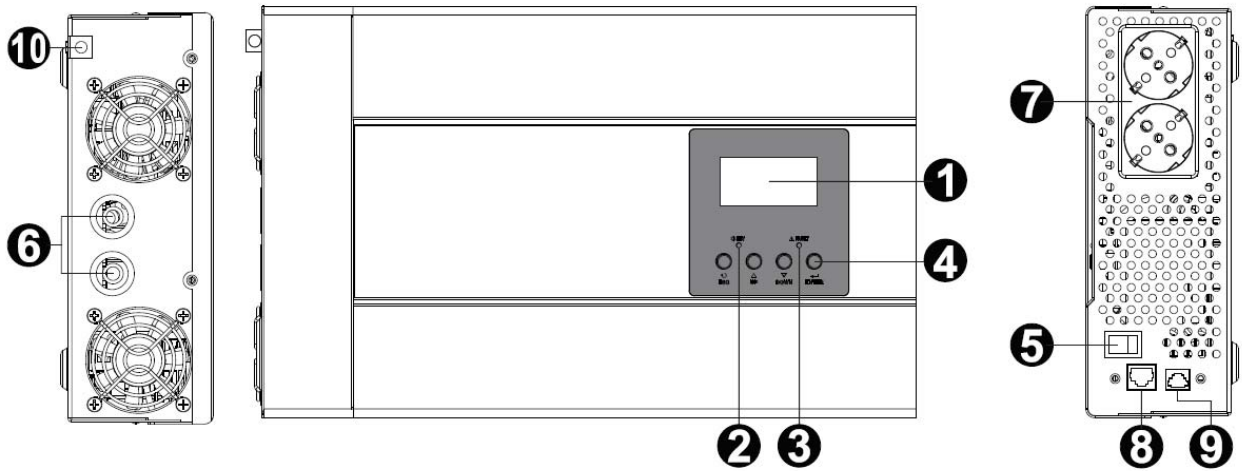

1. LCD display
2. Status indicator
3. Fault indicator
4. Function buttons
5. Power on/off switch
6. Battery input
7. AC output
8. Communication port
9. Remote on/off control port
10. GND Terminal

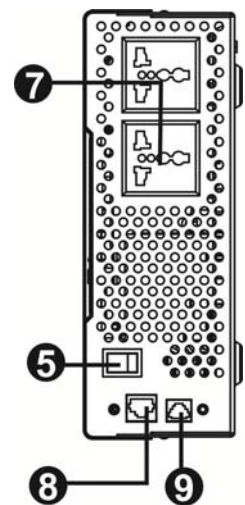

3. Safety Instructions



WARNING: This manual contains important safety and operating instructions. Read this manual carefully before installations and operations, keep it for future reference.

1. Before using the unit, read all instructions and cautionary markings on the unit, the batteries and all appropriate sections of this manual.
2. Do not disassemble the unit. Take it to a qualified service center when service or repair is required. Incorrect re-assembly may result in a risk of electric shock or fire.
3. To reduce risk of electric shock, disconnect all wirings before attempting any maintenance or cleaning. Turning off the unit will not reduce this risk.
4. **CAUTION** – Only qualified personnel can install this device with battery.
5. Be very cautious when working with metal tools on or around batteries. A potential risk exists to drop a tool to spark or short circuit batteries or other electrical parts and could cause an explosion.
6. Please strictly follow installation procedure when you want to disconnect DC terminals. Please refer to INSTALLATION section of this manual for the details.
7. GROUNDING INSTRUCTIONS -Inverter should be connected to a permanent grounded wiring system. Be sure to comply with local requirements and regulation to install.
8. NEVER cause AC output and DC input short circuited.
9. **Warning!!** Only qualified service persons are able to service this device. If errors still persist after following troubleshooting table, please send this inverter back to local dealer or service center for maintenance.

4. Installation

NOTE: Before installation, please inspect the unit. Be sure that nothing inside the package is damaged. You should have received the following items inside of package:

- The unit x 1
- User manual x 1
- Communication cable x 1
- Mounting bracket x 2

Mounting the Unit

Please utilize the delivered mounting brackets for problem-free installation of the inverter. Installation to the wall should be implemented with the proper screws. Mount the wall bracket so that the inverter can be easily attached to the wall. After that, the device should be bolted on securely.

1. Screw two mounting brackets on the back of the inverter with supplied screws as shown in chart.
2. Mount the mounting plate with appropriate screws (M4 or M5) into four holes to fix the unit in place.

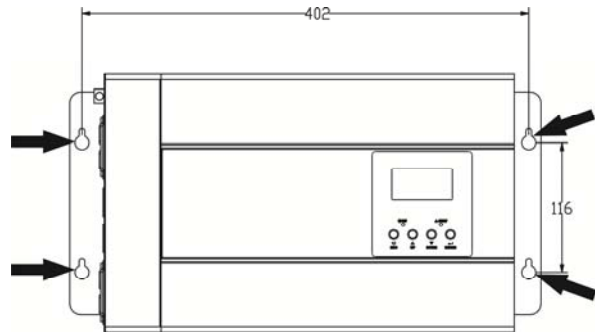
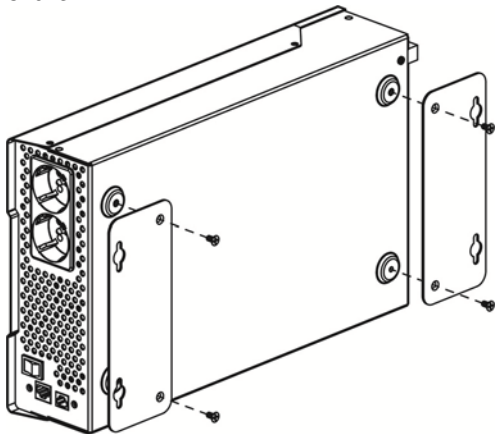

3. Check if the inverter is firmly secured.

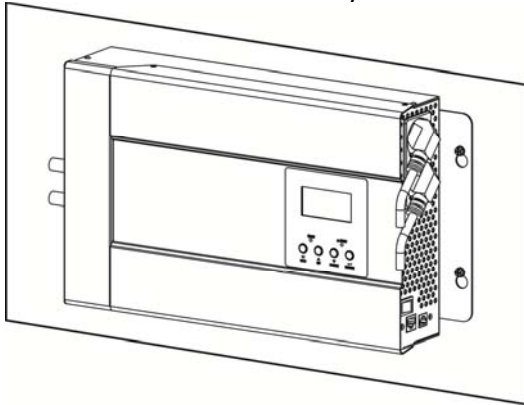

Battery Connection

Before connecting battery wirings, please take off bottom cover by removing two screws as shown below.

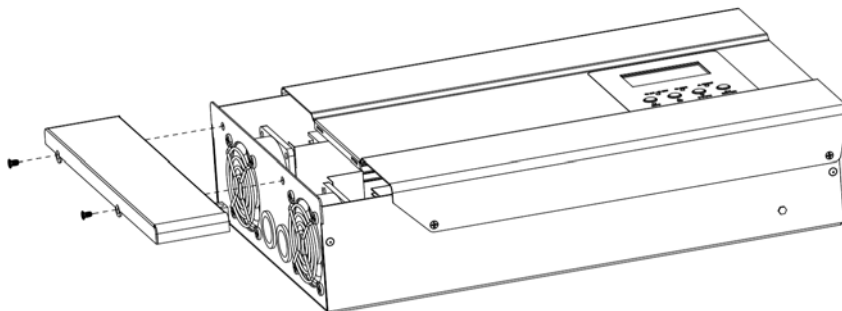

CAUTION: For safety operation and regulation compliance, it's requested to install a separate DC over-current protector or disconnect device between battery and inverter. It may not be requested to have a disconnect device in some applications, however, it's still requested to have over-current protection installed. Please refer to typical amperage in below table as required fuse or breaker size.

WARNING! All wiring must be performed by a qualified personnel.

WARNING! It's very important for system safety and efficient operation to use appropriate cable for battery connection. To reduce risk of injury, please use the proper recommended cable and terminal size as below.

Ring terminal:

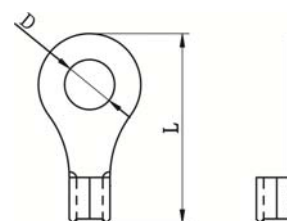

Recommended battery cable and terminal size:

Model	Typical Amperage	Battery capacity	Wire Size	Ring Terminal			Torque value
				Cable mm ²	Dimensions		
					D (mm)	L (mm)	
2KVA	66A	100AH	1*6AWG	14	6.4	29.2	2~ 3 Nm
			2*10AWG	8	6.4	23.8	
3KVA	100A	100AH	1*4AWG	22	6.4	33.2	2~ 3 Nm
		200AH	2*8AWG	14	6.4	29.2	

Please follow below steps to implement battery connection:

1. Assemble battery ring terminal based on recommended battery cable and terminal size.
2. 2KVA/3KVA model supports 24VDC system. Connect all battery packs as below chart. It's suggested to connect at least 100Ah capacity battery.

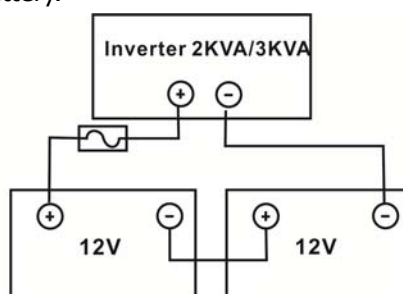

NOTE: Please only use sealed lead acid battery or sealed GEL/AGM lead-acid battery.

3. Insert the ring terminal of battery cable flatly into battery connector of inverter and make sure the bolts are tightened with torque of 2-3 Nm. Make sure polarity at both the battery and the inverter is correctly

connected and ring terminals are tightly screwed to the battery terminals.

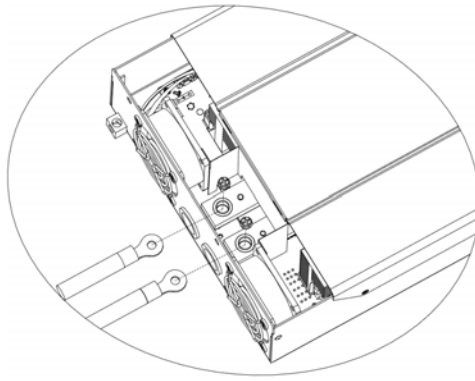

4. Fixing the bottom cover on the unit by two screws, refer to the picture in step 1.

	WARNING: Shock Hazard Installation must be performed with care due to high battery voltage in series.
--	---

	CAUTION!! Do not place anything between the flat part of the inverter terminal and the ring terminal. Otherwise, overheating may occur. CAUTION!! Do not apply anti-oxidant substance on the terminals before terminals are connected tightly. CAUTION!! Before making the final DC connection or closing DC breaker/disconnector, be sure positive (+) must be connected to positive (+) and negative (-) must be connected to negative (-).
--	--

AC Output Connection

Connect the load to the output sockets.

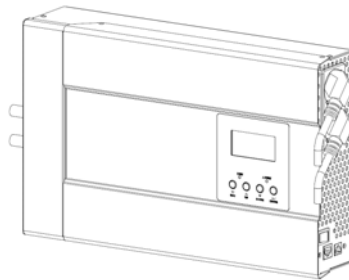

5. OPERATION

Power ON/OFF

Once the unit has been properly installed and the batteries are connected well, simply press On/Off switch to turn on the unit. The unit will work automatically. When press the switch again, the unit will be turned off.

Operation and Display Panel

The operation and display panel, shown in below chart, is on the front panel of the inverter. It includes three indicators, four function keys and a LCD display, indicating the operating status and input/output

power information.

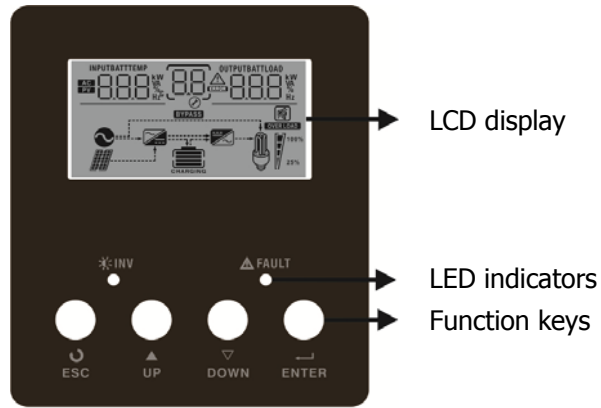

LED Indicator

LED Indicator		Messages	
INV	Green	Flashing	Output is powered in inverter mode.
FAULT	Red	Solid On	Fault occurs in the inverter.
		Flashing	Warning condition occurs in the inverter.



Function Keys

Function Key	Description
ESC	To exit setting mode
UP	To go to previous selection
DOWN	To go to next selection
ENTER	To confirm the selection in setting mode or enter setting mode

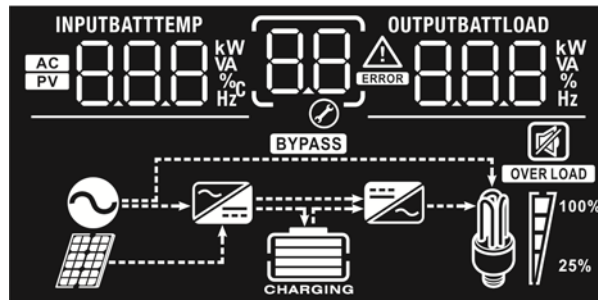
LCD Display Icons



Icon	Function description
Input Source Information	
	Indicate battery voltage.
Configuration Program and Fault Information	
	Indicates the setting programs.
	Indicates the warning and fault codes.

	<p>Warning:  flashing with warning code.</p> <p>Fault:  lighting with fault code</p>
--	--













Output Information

<p>OUTPUTBATTLOAD</p> <p></p>	Indicate output voltage, output frequency, load percent, load in VA and load in Watt.
---	---





Battery Information

	Indicates battery level by 0-24%, 25-49%, 50-74% and 75-100%.
---	---

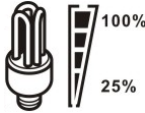

Battery capacity be presented as below.

Load Percentage	Battery Voltage	LCD Display
Load > 50%	< 1.717V/cell	
	1.717V/cell ~ 1.8V/cell	
	1.8 ~ 1.883V/cell	
	> 1.883 V/cell	
50% > Load > 20%	< 1.817V/cell	
	1.817V/cell ~ 1.9V/cell	
	1.9 ~ 1.983V/cell	
	> 1.983	
Load < 20%	< 1.867V/cell	
	1.867V/cell ~ 1.95V/cell	
	1.95 ~ 2.033V/cell	
	> 2.033	

Load Information

OVER LOAD	Indicates overload.			
	Indicates the load level by 0-24%, 25-50%, 50-74% and 75-100%.			
	0%~25%	25%~50%	50%~75%	75%~100%
				

Mode Operation Information

	Indicates the DC/AC inverter circuit is working.
Mute Operation	
	Indicates unit alarm is disabled.

LCD Setting

After pressing and holding ENTER button for 3 seconds, the unit will enter setting mode. Press "UP" or "DOWN" button to select setting programs. And then, press "ENTER" button to confirm the selection or ESC button to exit.





Setting Programs:

Program	Description	Selectable option	
00	Exit setting mode	Escape 00 ESC	
04	Power saving mode enable/disable	Saving mode disable (default) 04 SDS	If disabled, no matter connected load is low or high, the on/off status of inverter output will not be effected.
		Saving mode enable 04 SEN	If enabled, the output of inverter will be off when connected load is pretty low or not detected.
06	Auto restart when overload occurs	Restart disable (default) 06 Lfd	Restart enable 06 LfE
		Restart disable (default) 07 Lfd	Restart enable 07 LfE
09	Output frequency	50Hz (default) 09 50 Hz	60Hz 09 60 Hz
18	Alarm control	Alarm on (default) 18 bOn	Alarm off 18 bOf
19	Auto return to default display screen	Return to default display screen (default) 19 ESP	If selected, no matter how users switch display screen, it will automatically return to default display screen (Input voltage /output voltage) after no button is pressed for 1 minute.
		Stay at latest screen 19 LfEP	If selected, the display screen will stay at latest screen user finally switches.

20	Backlight control	Backlight on (default) 20 LON	Backlight off 20 LOF
25	Record Fault code	Record enable 25 FEN	Record disable (default) 25 FDS

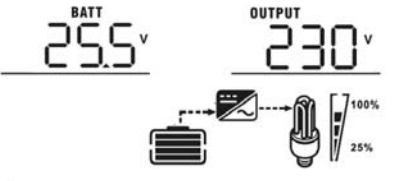
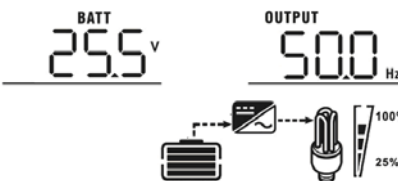
Display Setting

The LCD display information will be switched in turns by pressing "UP" or "DOWN" key. The selectable information is switched as below order: battery voltage, output voltage, output frequency, load percentage, load in Watt, load in VA.

Selectable information	LCD display
Battery voltage/Output voltage (Default Display Screen)	Battery voltage=25.5V, output voltage=230V 
Output frequency	Battery voltage=25.5V, Output frequency=50Hz 
Load percentage	Battery voltage=25.5V, Load percentage=70% 
Load in VA	When connected load is lower than 1kVA, load in VA will present xxxVA like below chart.  When load is larger than 1kVA ($\geq 1\text{kVA}$), load in VA will present x.xkVA like below chart. 

Load in Watt	<p>When load is lower than 1kW, load in W will present xxxW like below chart.</p> <div style="display: flex; justify-content: space-around; align-items: center;"> <div style="text-align: center;"> <p>BATT</p> <p>25.5^v</p> </div> <div style="text-align: center;"> <p>LOAD</p> <p>270^W</p> </div> </div> <div style="text-align: center; margin-top: 10px;"> </div>
	<p>When load is larger than 1kW ($\geq 1\text{KW}$), load in W will present x.xkW like below chart.</p> <div style="display: flex; justify-content: space-around; align-items: center;"> <div style="text-align: center;"> <p>BATT</p> <p>25.5^v</p> </div> <div style="text-align: center;"> <p>LOAD</p> <p>1.20^{kW}</p> </div> </div> <div style="text-align: center; margin-top: 10px;"> </div>





Operating Mode Description

Operation mode	Description	LCD display
Standby mode / Fault mode	No output is supplied by the unit.	
Battery Mode	The unit will provide output power from battery and PV power.	<p>Power from battery.</p>

Fault Reference Code

Fault Code	Fault Event	Icon on
01	Fan is locked when inverter is off.	01 _{ERR}
02	Over temperature	02 _{ERR}
03	Battery voltage is too high	03 _{ERR}
04	Battery voltage is too low	04 _{ERR}
05	Output short circuited or over temperature is detected by internal converter components.	05 _{ERR}
06	Output voltage is abnormal.	06 _{ERR}
07	Overload time out	07 _{ERR}
08	Bus voltage is too high	08 _{ERR}
09	Bus soft start failed	09 _{ERR}

Warning Indicator

Warning Code	Warning Event	Audible Alarm	Icon flashing
01	Fan is locked when inverter is on.	Beep three times every second	
03	High battery	Beep once every second	
04	Low battery	Beep once every second	
07	Overload	Beep once every 0.5 second	

6. SPECIFICATIONS

INVERTER MODEL	2KVA	3KVA
Rated Output Power	2KVA/1.6KW	3KVA/2.4KW
Output Voltage Waveform	Pure Sine Wave	
Output Voltage Regulation	230Vac±5%	
Output Frequency	50Hz	
Peak Efficiency	90%	
Overload Protection	5s@≥150% load; 10s@110%~150% load	
Surge Capacity	2* rated power for 5 seconds	
Nominal DC Input Voltage	24Vdc	
Cold Start Voltage	23.0Vdc	
Low DC Warning Voltage		
@ load < 20%	22.0Vdc	
@ 20% ≤ load < 50%	21.4Vdc	
@ load ≥ 50%	20.2Vdc	
Low DC Warning Return Voltage		
@ load < 20%	23.0Vdc	
@ 20% ≤ load < 50%	22.4Vdc	
@ load ≥ 50%	21.2Vdc	
Low DC Cut-off Voltage		
@ load < 20%	21.0Vdc	
@ 20% ≤ load < 50%	20.4Vdc	
@ load ≥ 50%	19.2Vdc	
High DC Recovery Voltage	29Vdc	
High DC Cut-off Voltage	31Vdc	
No Load Power Consumption	<20W	
Saving Mode Power Consumption	<10W	
Operating Temperature Range	0°C to 55°C	
Storage temperature	-15°C~ 60°C	
Humidity	5% to 95% Relative Humidity (Non-condensing)	
Dimension (D*W*H), mm	369 x 232 x 82	
Net Weight, kg	4.3	

7. TROUBLE SHOOTING

Problem	LCD/LED/Buzzer	Explanation / Possible cause	What to do
Unit shuts down automatically during startup process.	LCD/LEDs and buzzer will be active for 3 seconds and then complete off.	The battery voltage is too low (<1.91V/Cell)	1. Charge battery. 2. Replace battery.
No response after power on.	No indication.	1. The battery voltage is far too low. (<1.4V/Cell) 2. Battery polarity is connected reversed.	1. Check if batteries and the wiring are connected well. 2. Charge battery. 3. Replace battery.
Buzzer beeps continuously and red LED is on.	Fault code 07	Overload error. The inverter is overload 110% and time is up.	Reduce the connected load by switching off some equipment.
	Fault code 05	Output short circuited.	Check if wiring is connected well and remove abnormal load.
		Temperature of internal converter component is over 120°C.	Check whether the air flow of the unit is blocked or whether the ambient temperature is too high.
	Fault code 02	Internal temperature of inverter component is over 100°C.	Check if spec and quantity of batteries are meet requirements.
	Fault code 03	The battery voltage is too high.	Check if spec and quantity of batteries are meet requirements.
	Fault code 01	Fan fault	Replace the fan.
	Fault code 06	Output abnormal (Inverter voltage below than 190Vac or is higher than 260Vac)	1. Reduce the connected load. 2. Return to repair center
	Fault code 08/09	Internal components failed.	Return to repair center.

Appendix: Approximate Back-up Time Table

Model	Load (VA)	Backup Time @ 24Vdc 100Ah (min)	Backup Time @ 24Vdc 200Ah (min)
2KVA	200	766	1610
	400	335	766
	600	198	503
	800	139	339
	1000	112	269
	1200	95	227
	1400	81	176
	1600	62	140
	1800	55	125
	2000	50	112
3KVA	300	449	1100
	600	222	525
	900	124	303
	1200	95	227
	1500	68	164
	1800	56	126
	2100	48	108
	2400	35	94
	2700	31	74
	3000	28	67

Note: Backup time depends on the quality of the battery, age of battery and type of battery.
Specifications of batteries may vary depending on different manufacturers.