

Thank you for purchasing Modbus Card. This manual contains instructions and warnings that should be followed during the installation, operating and storage of the card. Please keep this manual for further reference.

Special Precautions

- If the card must be stored prior to installation; storage must be in a dry place.
- The admissible storage temperature range is from -10°C to +70°C.

1. Product Overview

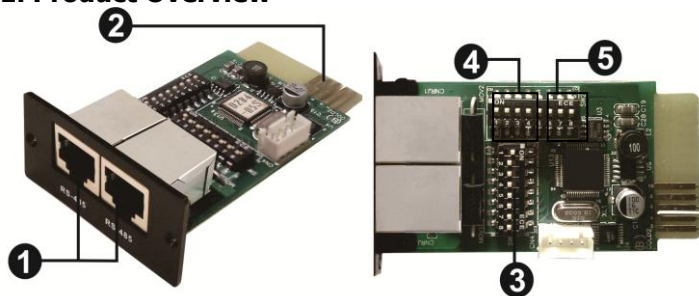

- ❶ RS-485 port
- ❷ Golden finger
- ❸ Address switch
- ❹ Communication setting
- ❺ Resistance switch

2. Product Introduction

Note: Default setting for baud rate is 19200bps.

1) For single inverter application: Equipped with Modbus card, hybrid inverter is connected to energy meter with RS485 communication port. It's to arrange self-consumption via Modbus card to control power generation and battery charging of the inverter.

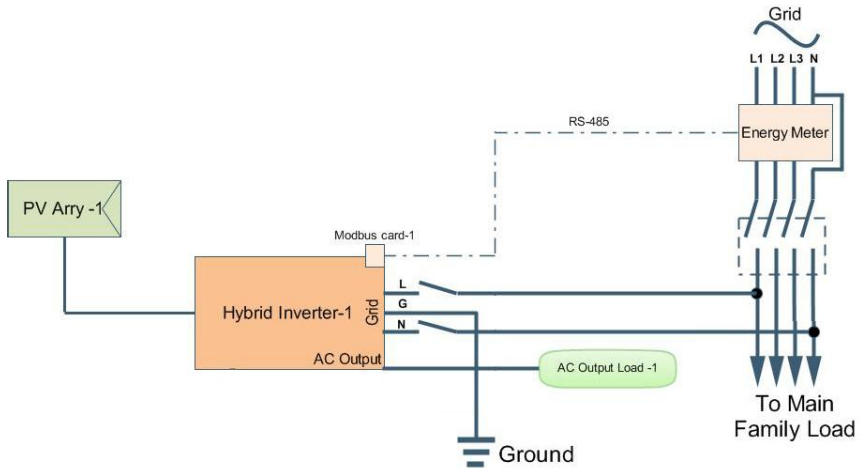

2) For three-inverter application: Equipped with Modbus card, three hybrid inverters are connected to energy meter with RS485 communication port. As a control center, Modbus server will control power generation and battery charging of three inverters via Modbus card for successful self-consumption.

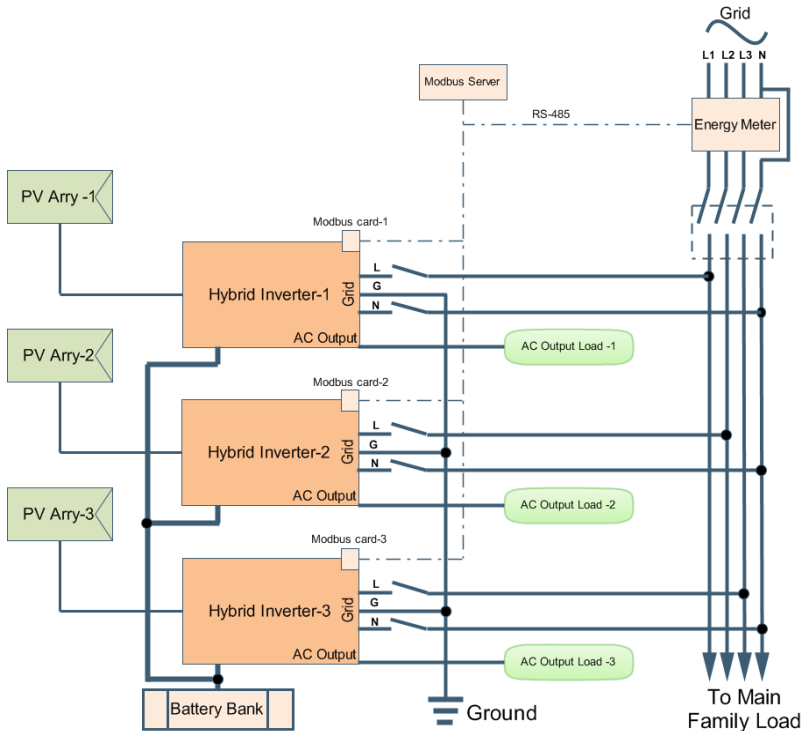

3. Installation and Operation

Follow below steps to install and use this modbus card:

1. Configure Modbus ID (Refer to section 4.1 for the details)
2. Configure communication format (Refer to section 4.2 for the details)
3. Install modbus card into inverter.
4. Configure and Connect inverter. If connecting single inverter, please refer to section 5 for the details. If connecting three inverters, please refer to section 6 for details.

4. Configuration

4.1 Machine ID Configuration

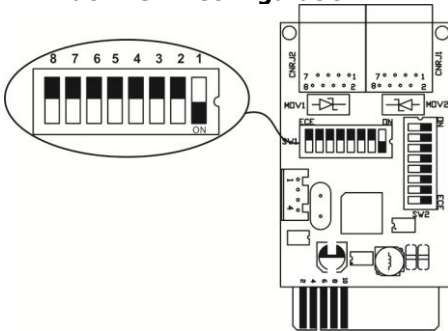

There are eight bits to present ID of each card. Use SW1 to set machine ID. From left to right, it's 8 to 1. As shown, when the switch is pushed down, the bit is set to "one". Otherwise, the bit is set as zero. The ID of modbus card is set to 0x01 as chart. Please check appendix for detailed ID no. and SW1 setting.

4.2 Hardware Setting

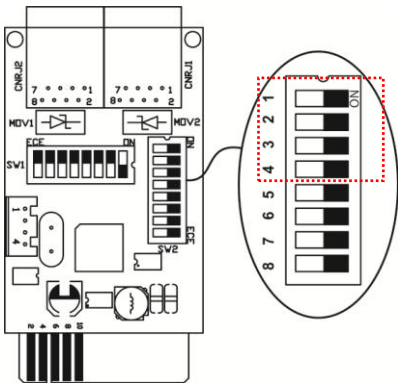

| Function | Bit Setting | | Meaning |
|--------------|-------------|-----|---------------------------------------|
| Working mode | # 2 | # 1 | |
| | OFF | OFF | Working in server mode |
| | ON | ON | Working in single mode |
| Parity check | # 4 | # 3 | |
| | OFF | OFF | Even parity |
| | ON | OFF | Odd parity |
| | OFF | ON | No parity check 1 stop bits (Default) |
| | ON | ON | No parity check 2 stop bits |

4.3 RS-485 Resistance Configuration

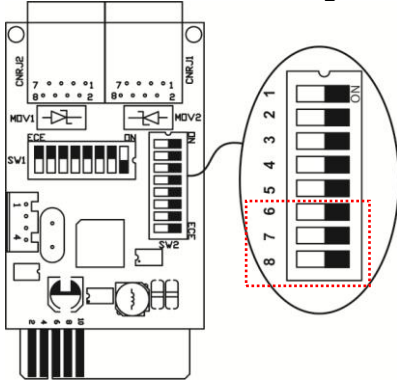

| Function | Bit # | Setting | Meaning |
|----------------------|-------|---------|------------------|
| Push up resistance | # 6 | ON | Enable (Default) |
| | | OFF | Disable |
| Push down resistance | # 7 | ON | Enable (Default) |
| | | OFF | Disable |
| Terminate resistance | # 8 | ON | Enable (Default) |
| | | OFF | Disable |

4.4 Interface Configuration

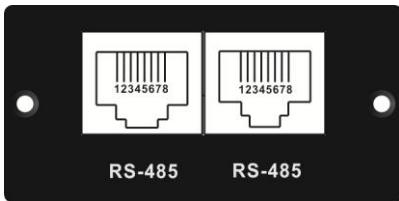

RS-485 Pin Configuration

| Pin | Function |
|-----|------------|
| 4 | RS-485 - B |
| 5 | RS-485 - A |
| 8 | GND |

5. Single Inverter Connection

5.1. Configuration

CAUTION: Before wiring connection, make sure that configurations of modbus card and energy meter are the same.

1) Energy meter configuration

Setting parameters:

| Name | modbus ID | bate rate(bps) | parity check | stop bit |
|--------------|-----------|----------------|--------------|----------|
| Energy meter | 1 | 19200 | NONE | 1 |

A. Enter set-up mode before setting up all parameters.





To enter set-up mode, press  button for 3 seconds until password screen appears.





Setting-up is password-protected. It's requested to enter correct password (default '1000') before proceeding. If an incorrect password is entered, the screen will display "Err".









B. Set up modbus ID (modbus address) as 001.











| | | |
|---|--|--|
| 1 | A photograph of a blue LCD screen. The top line displays "SET" in white capital letters. The second line displays "Addr" in white capital letters. The third line displays "001" in white capital letters. | From main menu, press  or  to jump to modbus address (Addr). Press  to enter options. |
| 2 | A photograph of a blue LCD screen. The top line displays "SET" in white capital letters. The second line displays "Addr" in white capital letters. The third line displays "001" in white capital letters. | Press  or  to enter numbers. The range is from 0 to 247. |

C. Set up baud rate as 19.2K Hz





| | | |
|---|---|---|
| 1 | A photograph of a blue LCD screen. The top line displays "SET" in white capital letters. The second line displays "BAUD" in white capital letters. The third line displays "9.6" in white capital letters, followed by a small "k" to its right. | From main menu, press  or  to jump to Baud Rate. Press  to enter Baud Rate options. |
| 2 | A photograph of a blue LCD screen. The top line displays "SET" in white capital letters. The second line displays "BAUD" in white capital letters. The third line displays "9.6" in white capital letters, followed by a small "k" to its right. The "9.6" is circled in red. | The current setting will flash. |







| | | |
|---|---|--|
| 3 |  | <p>Press  or  to view all options in order. There are four options available to choose: 2.4k, 4.8k, 9.6k, 19.2k and 38.4k.</p> |
| 4 |  | <p>When 19.2k is displayed, press  to confirm setting. Then, press  to return to main menu.</p> |

D. Set up parity as NONE

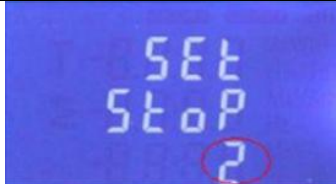
| | | |
|---|--|--|
| 1 |  | <p>From the main menu, press  or  to jump to Parity (PARI). Press  to enter Parity options.</p> |
| 2 |  | <p>The current setting will flash. Press  or  to view all options in order. There are three options available to choose: EVEN, ODD and NONE.</p> |
| 3 |  | <p>When NONE is displayed, press  to confirm setting. Then, press  to return to main menu.</p> |

E. Set up stop bit as 1

| | | |
|---|---|--|
| 1 |  | <p>From the main menu, press  or  to jump to STOP (StoP). Press  to enter Stop options.</p> |
|---|---|--|

| | | |
|---|---|--|
| 2 |  | <p>The current setting will flash. Press  or  to view all options in order. There are two options available to choose: 1 or 2.</p> |
| 3 |  | <p>When 1 is displayed, press  to confirm setting. Then, press  to return to main menu.</p> |

2) Modbus card configuration

Setting parameters:

| Name | modbus ID | bate rate(bps) | parity check | stop bit |
|--|-----------|----------------|--------------|----------|
| Modbus card | 1 | 19200 | NONE | 1 |
| Set up modbus card working in single mode. (Refer to section 4.2.) | | | | |

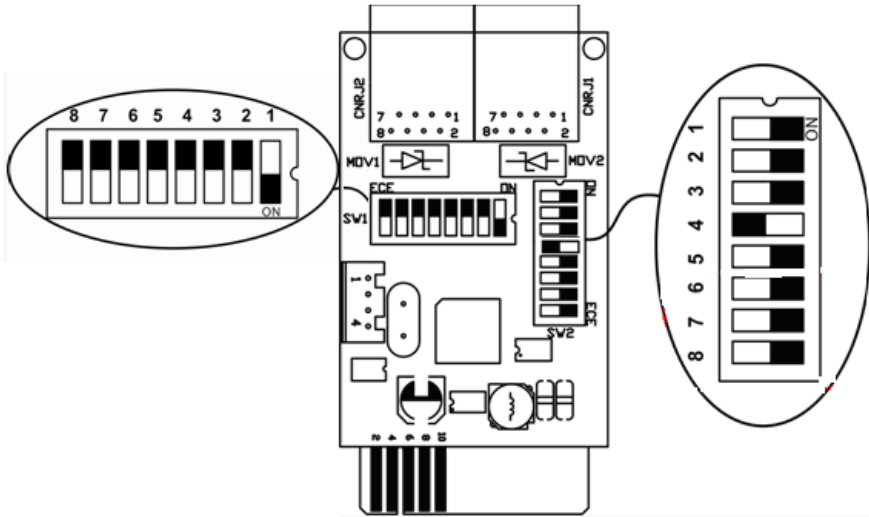

3) Inverter configuration

Setting parameters:

- A. PV energy supply priority setting: Grid-Tie with backup (II)
- B. Set up AC-charging duration at night such as "00:00-05:00" as default.

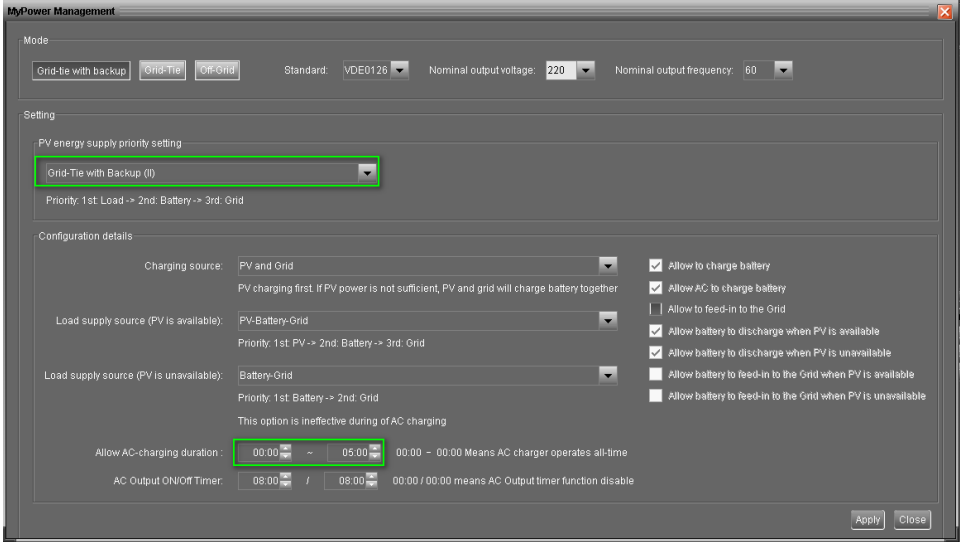

5.2. Wiring Connection

Please follow below chart for wiring connection between RJ45 and energy meter:

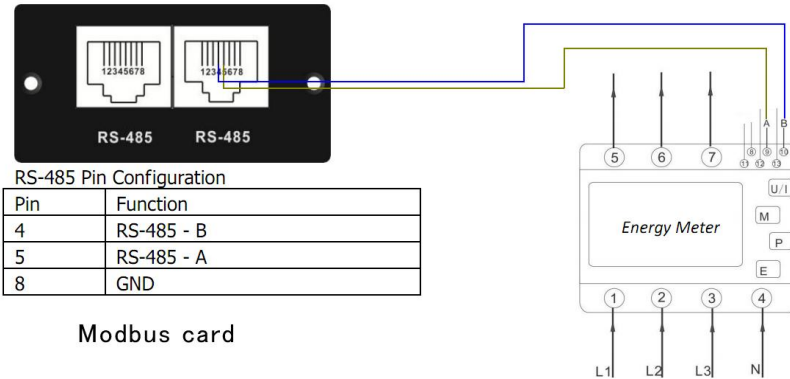

Modbus card

Single inverter connection

6 Three-inverter Connection

6.1. Configuration

CAUTION: Make sure that all modbus addresses are different in the modbus network and modbus cards are working in server mode.

1) Energy meter configuration (Refer to section 5.1 for the details)

Setting parameters:

| Name | modbus ID | bate rate(bps) | parity check | stop bit |
|--------------|-----------|----------------|--------------|----------|
| Energy meter | 1 | 19200 | NONE | 1 |

2) Modbus card configuration

Setting parameters for Modbus card No. 1:

| Name | modbus ID | bate rate(bps) | parity check | stop bit |
|-------------|--|----------------|--------------|----------|
| Modbus card | 2 | 19200 | NONE | 1 |
| No. 1 | Setting modbus card in server mode. (Refer to section 4.2) | | | |

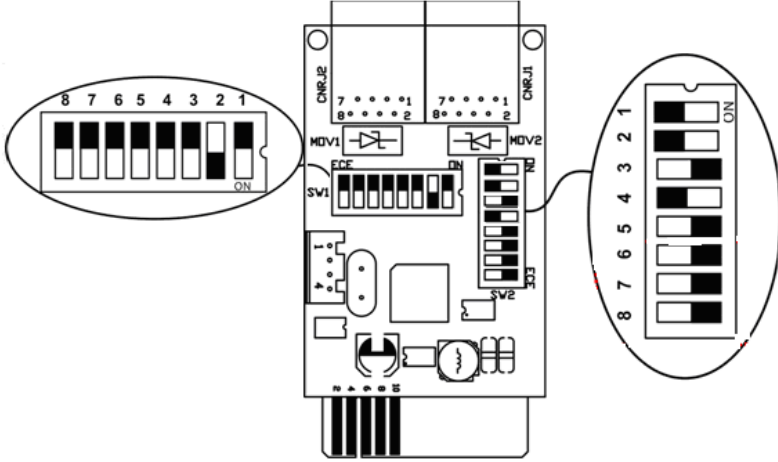

Setting parameters for Modbus card No. 2:

| Name | modbus ID | bate rate(bps) | parity check | stop bit |
|-------------|--|----------------|--------------|----------|
| Modbus card | 3 | 19200 | NONE | 1 |
| No. 2 | Setting modbus card in server mode. (Refer to section 4.2) | | | |

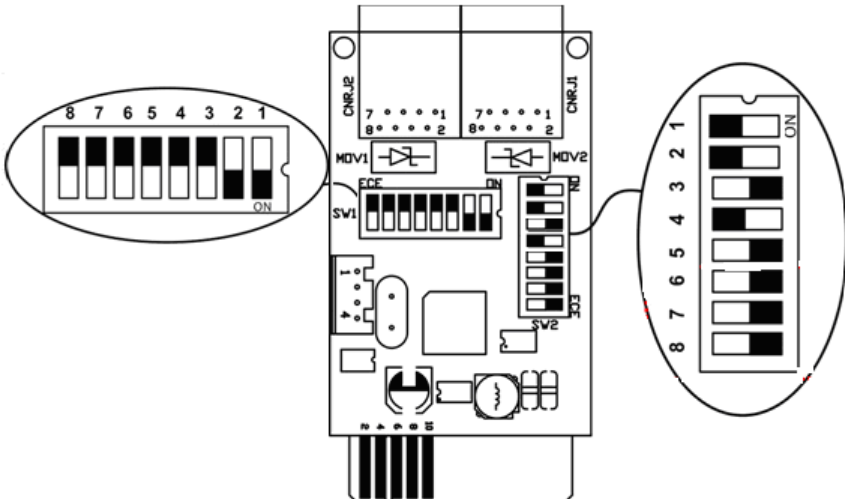

Setting parameters for Modbus card No. 3:

| Name | modbus ID | bate rate(bps) | parity check | stop bit |
|--|-----------|----------------|--------------|----------|
| Modbus card No. 3 | 4 | 19200 | NONE | 1 |
| Setting modbus card in server mode. (Refer to section 4.2) | | | | |

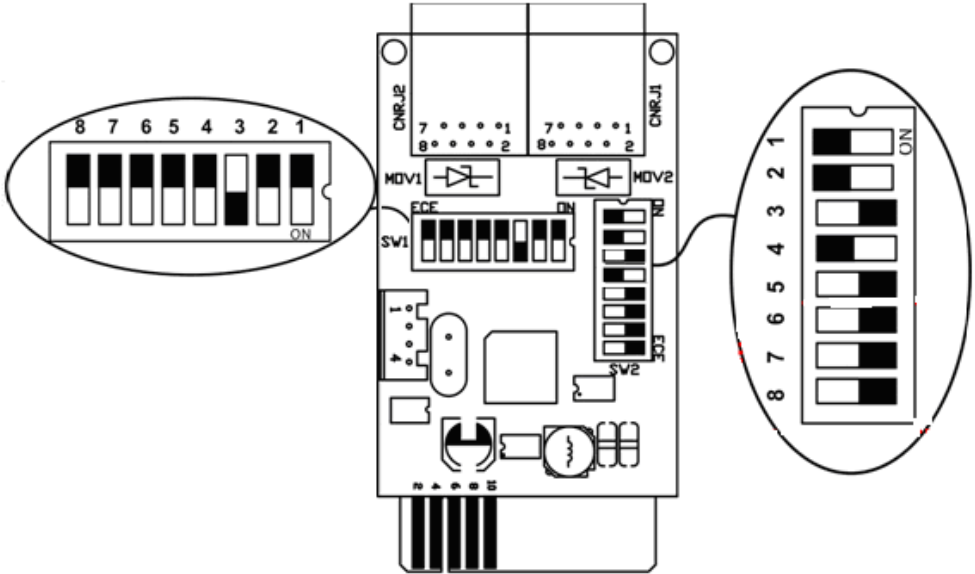

3) Inverter configuration (Refer to section 5.1 inverter configuration for the details)

Set hybrid inverter parameter:

- A. PV energy supply priority setting: Grid-Tie with backup (II)
- B. Set up AC-charging duration at night such as "00:00-05:00" as default.

6.2. Wiring Connection (Check section 5.2 for first modbus wiring to energy meter)

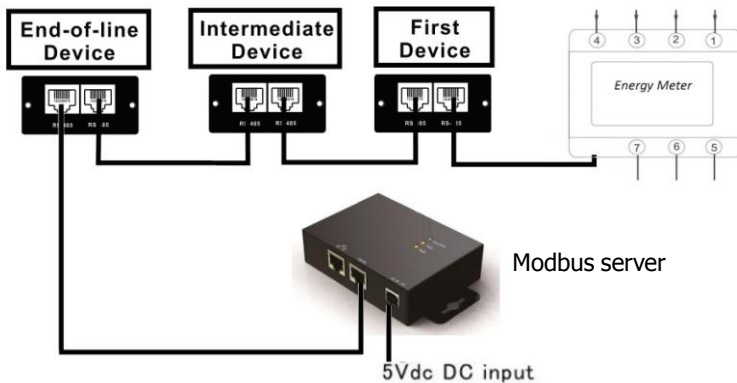

Three-inverter connection with modbus server

APPENDIX: Machine ID Configuration Table (SW1) √=ON ×=OFF

| SW1 ID | Bit 1 | Bit 2 | Bit 3 | Bit 4 | Bit 5 | Bit 6 | Bit 7 | Bit 8 |
|-----------|-------|-------|-------|-------|-------|-------|-------|-------|
| 1 | √ | × | × | × | × | × | × | × |
| 2 | × | √ | × | × | × | × | × | × |
| 3 | √ | √ | × | × | × | × | × | × |
| 4 | × | × | √ | × | × | × | × | × |
| 5 | √ | × | √ | × | × | × | × | × |
| 6 | × | √ | √ | × | × | × | × | × |
| 7 | √ | √ | √ | × | × | × | × | × |
| 8 | × | × | × | √ | × | × | × | × |
| 9 | √ | × | × | √ | × | × | × | × |
| 10 | × | √ | × | √ | × | × | × | × |
| 11 | √ | √ | × | √ | × | × | × | × |
| 12 | × | × | √ | √ | × | × | × | × |
| 13 | √ | × | √ | √ | × | × | × | × |
| 14 | × | √ | √ | √ | × | × | × | × |
| 15 | √ | √ | √ | √ | × | × | × | × |
| 16 | × | × | × | × | √ | × | × | × |
| 17 | √ | × | × | × | √ | × | × | × |
| 18 | × | √ | × | × | √ | × | × | × |
| 19 | √ | √ | × | × | √ | × | × | × |
| 20 | × | × | √ | × | √ | × | × | × |
| 21 | √ | × | √ | × | √ | × | × | × |
| 22 | × | √ | √ | × | √ | × | × | × |
| 23 | √ | √ | √ | × | √ | × | × | × |
| 24 | × | × | × | √ | √ | × | × | × |
| 25 | √ | × | × | √ | √ | × | × | × |
| 26 | × | √ | × | √ | √ | × | × | × |
| 27 | √ | √ | × | √ | √ | × | × | × |
| 28 | × | × | √ | √ | √ | × | × | × |
| 29 | √ | × | √ | √ | √ | × | × | × |
| 30 | × | √ | √ | √ | √ | × | × | × |
| 31 | √ | √ | √ | √ | √ | × | × | × |
| 32 | × | × | × | × | × | √ | × | × |
| 33 | √ | × | × | × | × | √ | × | × |
| 34 | × | √ | × | × | × | √ | × | × |
| 35 | √ | √ | × | × | × | √ | × | × |
| 36 | × | × | √ | × | × | √ | × | × |
| 37 | √ | × | √ | × | × | √ | × | × |
| 38 | × | √ | √ | × | × | √ | × | × |
| 39 | √ | √ | √ | × | × | √ | × | × |

| | | | | | | | | |
|----|---|---|---|---|---|---|---|---|
| 40 | x | x | x | √ | x | √ | x | x |
| 41 | √ | x | x | √ | x | √ | x | x |
| 42 | x | √ | x | √ | x | √ | x | x |
| 43 | √ | √ | x | √ | x | √ | x | x |
| 44 | x | x | √ | √ | x | √ | x | x |
| 45 | √ | x | √ | √ | x | √ | x | x |
| 46 | x | √ | √ | √ | x | √ | x | x |
| 47 | √ | √ | √ | √ | x | √ | x | x |
| 48 | x | x | x | x | √ | √ | x | x |
| 49 | √ | x | x | x | √ | √ | x | x |
| 50 | x | √ | x | x | √ | √ | x | x |
| 51 | √ | √ | x | x | √ | √ | x | x |
| 52 | x | x | √ | x | √ | √ | x | x |
| 53 | √ | x | √ | x | √ | √ | x | x |
| 54 | x | √ | √ | x | √ | √ | x | x |
| 55 | √ | √ | √ | x | √ | √ | x | x |
| 56 | x | x | x | √ | √ | √ | x | x |
| 57 | √ | x | x | √ | √ | √ | x | x |
| 58 | x | √ | x | √ | √ | √ | x | x |
| 59 | √ | √ | x | √ | √ | √ | x | x |
| 60 | x | x | √ | √ | √ | √ | x | x |
| 61 | √ | x | √ | √ | √ | √ | x | x |
| 62 | x | √ | √ | √ | √ | √ | x | x |
| 63 | √ | √ | √ | √ | √ | √ | x | x |
| 64 | x | x | x | x | x | x | √ | x |
| 65 | √ | x | x | x | x | x | √ | x |
| 66 | x | √ | x | x | x | x | √ | x |
| 67 | √ | √ | x | x | x | x | √ | x |
| 68 | x | x | √ | x | x | x | √ | x |
| 69 | √ | x | √ | x | x | x | √ | x |
| 70 | x | √ | √ | x | x | x | √ | x |
| 71 | √ | √ | √ | x | x | x | √ | x |
| 72 | x | x | x | √ | x | x | √ | x |
| 73 | √ | x | x | √ | x | x | √ | x |
| 74 | x | √ | x | √ | x | x | √ | x |
| 75 | √ | √ | x | √ | x | x | √ | x |
| 76 | x | x | √ | √ | x | x | √ | x |
| 77 | √ | x | √ | √ | x | x | √ | x |
| 78 | x | √ | √ | √ | x | x | √ | x |
| 79 | √ | √ | √ | √ | x | x | √ | x |
| 80 | x | x | x | x | √ | x | √ | x |
| 81 | √ | x | x | x | √ | x | √ | x |

| | | | | | | | | |
|-----|---|---|---|---|---|---|---|---|
| 82 | x | √ | x | x | √ | x | √ | x |
| 83 | √ | √ | x | x | √ | x | √ | x |
| 84 | x | x | √ | x | √ | x | √ | x |
| 85 | √ | x | √ | x | √ | x | √ | x |
| 86 | x | √ | √ | x | √ | x | √ | x |
| 87 | √ | √ | √ | x | √ | x | √ | x |
| 88 | x | x | x | √ | √ | x | √ | x |
| 89 | √ | x | x | √ | √ | x | √ | x |
| 90 | x | √ | x | √ | √ | x | √ | x |
| 91 | √ | √ | x | √ | √ | x | √ | x |
| 92 | x | x | √ | √ | √ | x | √ | x |
| 93 | √ | x | √ | √ | √ | x | √ | x |
| 94 | x | √ | √ | √ | √ | x | √ | x |
| 95 | √ | √ | √ | √ | √ | x | √ | x |
| 96 | x | x | x | x | x | √ | √ | x |
| 97 | √ | x | x | x | x | √ | √ | x |
| 98 | x | √ | x | x | x | √ | √ | x |
| 99 | √ | √ | x | x | x | √ | √ | x |
| 100 | x | x | √ | x | x | √ | √ | x |
| 101 | √ | x | √ | x | x | √ | √ | x |
| 102 | x | √ | √ | x | x | √ | √ | x |
| 103 | √ | √ | √ | x | x | √ | √ | x |
| 104 | x | x | x | √ | x | √ | √ | x |
| 105 | √ | x | x | √ | x | √ | √ | x |
| 106 | x | √ | x | √ | x | √ | √ | x |
| 107 | √ | √ | x | √ | x | √ | √ | x |
| 108 | x | x | √ | √ | x | √ | √ | x |
| 109 | √ | x | √ | √ | x | √ | √ | x |
| 110 | x | √ | √ | √ | x | √ | √ | x |
| 111 | √ | √ | √ | √ | x | √ | √ | x |
| 112 | x | x | x | x | √ | √ | √ | x |
| 113 | √ | x | x | x | √ | √ | √ | x |
| 114 | x | √ | x | x | √ | √ | √ | x |
| 115 | √ | √ | x | x | √ | √ | √ | x |
| 116 | x | x | √ | x | √ | √ | √ | x |
| 117 | √ | x | √ | x | √ | √ | √ | x |
| 118 | x | √ | √ | x | √ | √ | √ | x |
| 119 | √ | √ | √ | x | √ | √ | √ | x |
| 120 | x | x | x | √ | √ | √ | √ | x |
| 121 | √ | x | x | √ | √ | √ | √ | x |
| 122 | x | √ | x | √ | √ | √ | √ | x |
| 123 | √ | √ | x | √ | √ | √ | √ | x |

| | | | | | | | | |
|-----|---|---|---|---|---|---|---|---|
| 124 | x | x | √ | √ | √ | √ | √ | x |
| 125 | √ | x | √ | √ | √ | √ | √ | x |
| 126 | x | √ | √ | √ | √ | √ | √ | x |
| 127 | √ | √ | √ | √ | √ | √ | √ | x |
| 128 | x | x | x | x | x | x | x | √ |
| 129 | √ | x | x | x | x | x | x | √ |
| 130 | x | √ | x | x | x | x | x | √ |
| 131 | √ | √ | x | x | x | x | x | √ |
| 132 | x | x | √ | x | x | x | x | √ |
| 133 | √ | x | √ | x | x | x | x | √ |
| 134 | x | √ | √ | x | x | x | x | √ |
| 135 | √ | √ | √ | x | x | x | x | √ |
| 136 | x | x | x | √ | x | x | x | √ |
| 137 | √ | x | x | √ | x | x | x | √ |
| 138 | x | √ | x | √ | x | x | x | √ |
| 139 | √ | √ | x | √ | x | x | x | √ |
| 140 | x | x | √ | √ | x | x | x | √ |
| 141 | √ | x | √ | √ | x | x | x | √ |
| 142 | x | √ | √ | √ | x | x | x | √ |
| 143 | √ | √ | √ | √ | x | x | x | √ |
| 144 | x | x | x | x | √ | x | x | √ |
| 145 | √ | x | x | x | √ | x | x | √ |
| 146 | x | √ | x | x | √ | x | x | √ |
| 147 | √ | √ | x | x | √ | x | x | √ |
| 148 | x | x | √ | x | √ | x | x | √ |
| 149 | √ | x | √ | x | √ | x | x | √ |
| 150 | x | √ | √ | x | √ | x | x | √ |
| 151 | √ | √ | √ | x | √ | x | x | √ |
| 152 | x | x | x | √ | √ | x | x | √ |
| 153 | √ | x | x | √ | √ | x | x | √ |
| 154 | x | √ | x | √ | √ | x | x | √ |
| 155 | √ | √ | x | √ | √ | x | x | √ |
| 156 | x | x | √ | √ | √ | x | x | √ |
| 157 | √ | x | √ | √ | √ | x | x | √ |
| 158 | x | √ | √ | √ | √ | x | x | √ |
| 159 | √ | √ | √ | √ | √ | x | x | √ |
| 160 | x | x | x | x | x | √ | x | √ |
| 161 | √ | x | x | x | x | √ | x | √ |
| 162 | x | √ | x | x | x | √ | x | √ |
| 163 | √ | √ | x | x | x | √ | x | √ |
| 164 | x | x | √ | x | x | √ | x | √ |
| 165 | √ | x | √ | x | x | √ | x | √ |

| | | | | | | | | |
|-----|---|---|---|---|---|---|---|---|
| 166 | x | √ | √ | x | x | √ | x | √ |
| 167 | √ | √ | √ | x | x | √ | x | √ |
| 168 | x | x | x | √ | x | √ | x | √ |
| 169 | √ | x | x | √ | x | √ | x | √ |
| 170 | x | √ | x | √ | x | √ | x | √ |
| 171 | √ | √ | x | √ | x | √ | x | √ |
| 172 | x | x | √ | √ | x | √ | x | √ |
| 173 | √ | x | √ | √ | x | √ | x | √ |
| 174 | x | √ | √ | √ | x | √ | x | √ |
| 175 | √ | √ | √ | √ | x | √ | x | √ |
| 176 | x | x | x | x | √ | √ | x | √ |
| 177 | √ | x | x | x | √ | √ | x | √ |
| 178 | x | √ | x | x | √ | √ | x | √ |
| 179 | √ | √ | x | x | √ | √ | x | √ |
| 180 | x | x | √ | x | √ | √ | x | √ |
| 181 | √ | x | √ | x | √ | √ | x | √ |
| 182 | x | √ | √ | x | √ | √ | x | √ |
| 183 | √ | √ | √ | x | √ | √ | x | √ |
| 184 | x | x | x | √ | √ | √ | x | √ |
| 185 | √ | x | x | √ | √ | √ | x | √ |
| 186 | x | √ | x | √ | √ | √ | x | √ |
| 187 | √ | √ | x | √ | √ | √ | x | √ |
| 188 | x | x | √ | √ | √ | √ | x | √ |
| 189 | √ | x | √ | √ | √ | √ | x | √ |
| 190 | x | √ | √ | √ | √ | √ | x | √ |
| 191 | √ | √ | √ | √ | √ | √ | x | √ |
| 192 | x | x | x | x | x | x | √ | √ |
| 193 | √ | x | x | x | x | x | √ | √ |
| 194 | x | √ | x | x | x | x | √ | √ |
| 195 | √ | √ | x | x | x | x | √ | √ |
| 196 | x | x | √ | x | x | x | √ | √ |
| 197 | √ | x | √ | x | x | x | √ | √ |
| 198 | x | √ | √ | x | x | x | √ | √ |
| 199 | √ | √ | √ | x | x | x | √ | √ |
| 200 | x | x | x | √ | x | x | √ | √ |
| 201 | √ | x | x | √ | x | x | √ | √ |
| 202 | x | √ | x | √ | x | x | √ | √ |
| 203 | √ | √ | x | √ | x | x | √ | √ |
| 204 | x | x | √ | √ | x | x | √ | √ |
| 205 | √ | x | √ | √ | x | x | √ | √ |
| 206 | x | √ | √ | √ | x | x | √ | √ |
| 207 | √ | √ | √ | √ | x | x | √ | √ |

| | | | | | | | | |
|-----|---|---|---|---|---|---|---|---|
| 208 | x | x | x | x | √ | x | √ | √ |
| 209 | √ | x | x | x | √ | x | √ | √ |
| 210 | x | √ | x | x | √ | x | √ | √ |
| 211 | √ | √ | x | x | √ | x | √ | √ |
| 212 | x | x | √ | x | √ | x | √ | √ |
| 213 | √ | x | √ | x | √ | x | √ | √ |
| 214 | x | √ | √ | x | √ | x | √ | √ |
| 215 | √ | √ | √ | x | √ | x | √ | √ |
| 216 | x | x | x | √ | √ | x | √ | √ |
| 217 | √ | x | x | √ | √ | x | √ | √ |
| 218 | x | √ | x | √ | √ | x | √ | √ |
| 219 | √ | √ | x | √ | √ | x | √ | √ |
| 220 | x | x | √ | √ | √ | x | √ | √ |
| 221 | √ | x | √ | √ | √ | x | √ | √ |
| 222 | x | √ | √ | √ | √ | x | √ | √ |
| 223 | √ | √ | √ | √ | √ | x | √ | √ |
| 224 | x | x | x | x | x | √ | √ | √ |
| 225 | √ | x | x | x | x | √ | √ | √ |
| 226 | x | √ | x | x | x | √ | √ | √ |
| 227 | √ | √ | x | x | x | √ | √ | √ |
| 228 | x | x | √ | x | x | √ | √ | √ |
| 229 | √ | x | √ | x | x | √ | √ | √ |
| 230 | x | √ | √ | x | x | √ | √ | √ |
| 231 | √ | √ | √ | x | x | √ | √ | √ |
| 232 | x | x | x | √ | x | √ | √ | √ |
| 233 | √ | x | x | √ | x | √ | √ | √ |
| 234 | x | √ | x | √ | x | √ | √ | √ |
| 235 | √ | √ | x | √ | x | √ | √ | √ |
| 236 | x | x | √ | √ | x | √ | √ | √ |
| 237 | √ | x | √ | √ | x | √ | √ | √ |
| 238 | x | √ | √ | √ | x | √ | √ | √ |
| 239 | √ | √ | √ | √ | x | √ | √ | √ |
| 240 | x | x | x | x | √ | √ | √ | √ |
| 241 | √ | x | x | x | √ | √ | √ | √ |
| 242 | x | √ | x | x | √ | √ | √ | √ |
| 243 | √ | √ | x | x | √ | √ | √ | √ |
| 244 | x | x | √ | x | √ | √ | √ | √ |
| 245 | √ | x | √ | x | √ | √ | √ | √ |
| 246 | x | √ | √ | x | √ | √ | √ | √ |
| 247 | √ | √ | √ | x | √ | √ | √ | √ |