

ARM-HS/MS Parallel Installation Demo

VO.1

1. Introduction

This demo is used as an additional instruction for the user manual. If you are unsure about the user manual, this demo should help clarify.

3 inverters are used in this demo; other numbers can be done in the same manner.

Warning: Please read this Demo carefully, the wrong setting or the wiring connection will damage the inverter permanently and not covered by warranty.

2. System overview

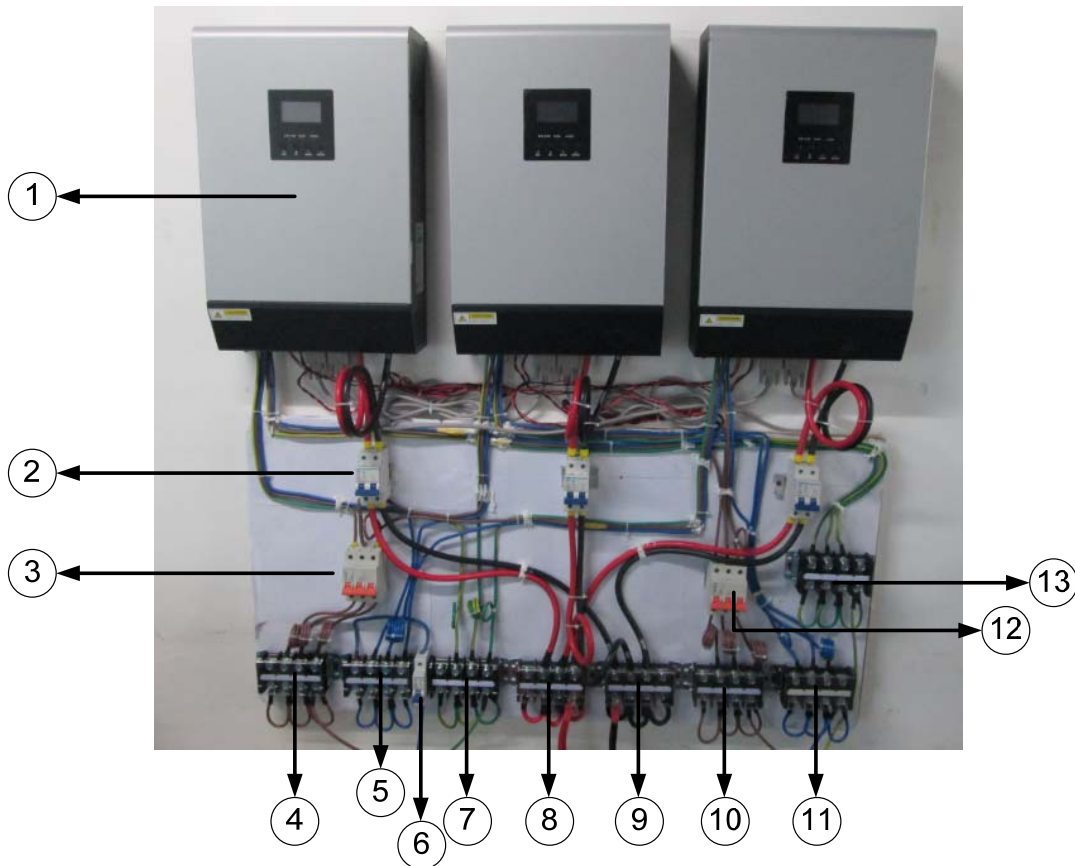

- | | |
|--|-------------------------------------|
| (1) Inverter | (2) Battery breaker |
| (3) Utility input line breaker | (4) Utility input line bus terminal |
| (5) Utility input neutral bus terminal | (6) Utility input neutral breaker |
| (7) Utility input ground bus terminal | (8) Battery positive bus terminal |
| (9) Battery negative bus terminal | (10) Load output line bus terminal |
| (11) Load output neutral bus terminal | (12) Load output line breaker |
| (13) Load output ground terminal | |

Note: The wire, terminal and breaker shown in the figure are just for reference, the actual

system requirement should follow the spec in the user manual.

3. Wiring connection

After we mounted the unit on the wall, we can start the wiring connection of the system.

3.1 Utility input cable connection

Refer to below figure for the connection of AC input line cable.

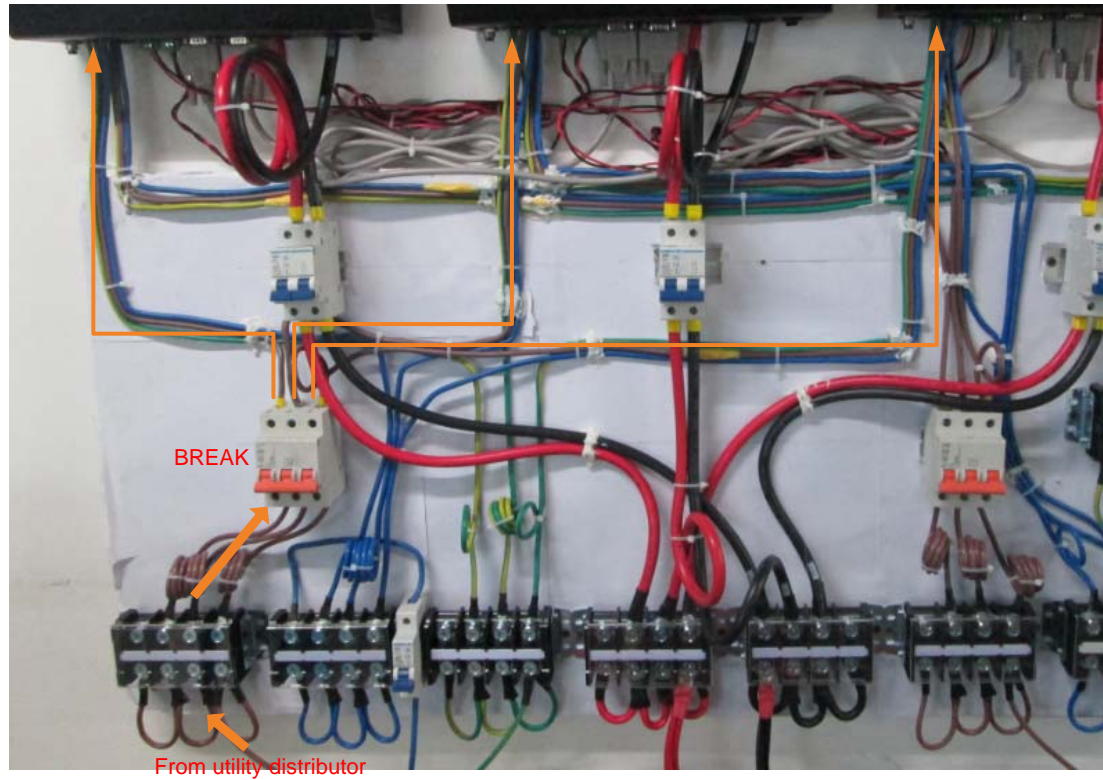

Refer to below figure for connection of AC input neutral cable.

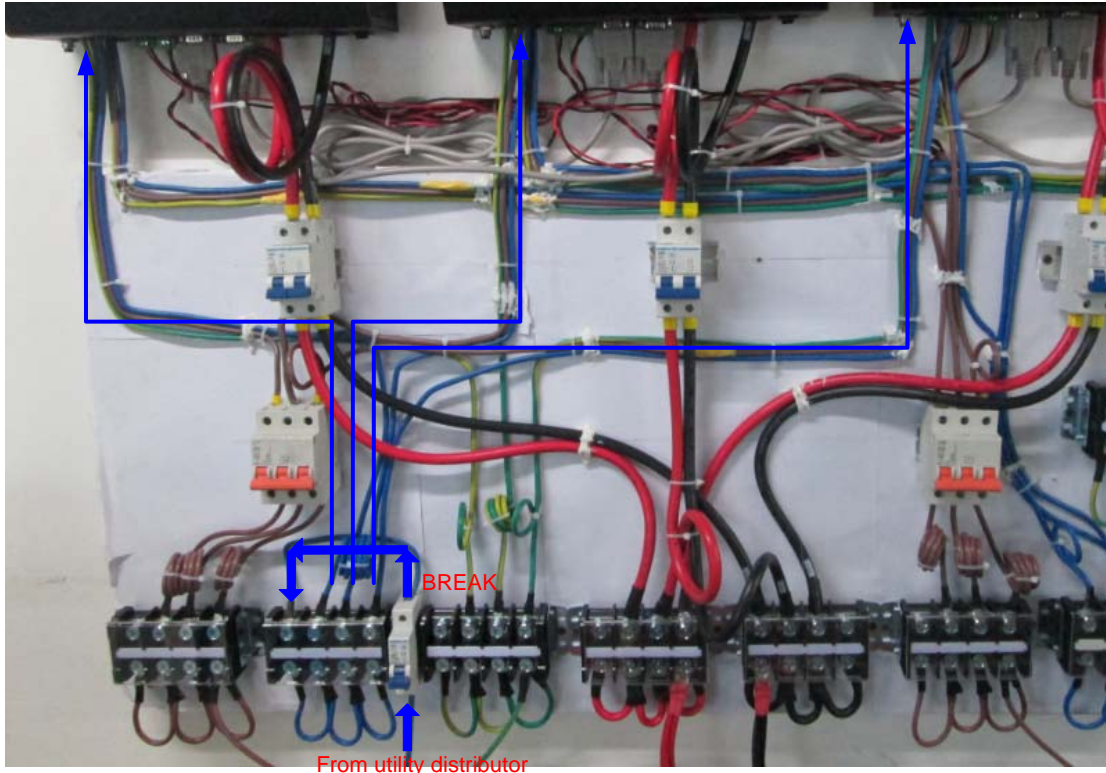

Refer to below figure for connection of AC input ground cable.

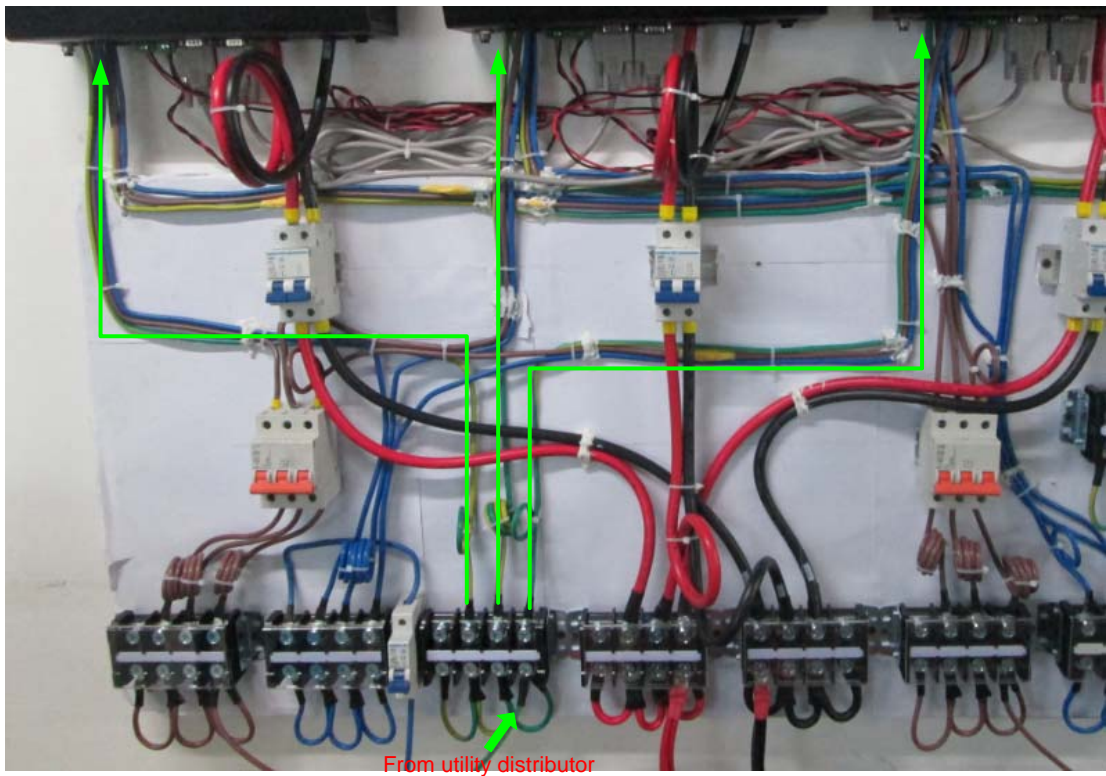

3.2 Load output cable connection

Refer to below figure for the connection of load output line cable.

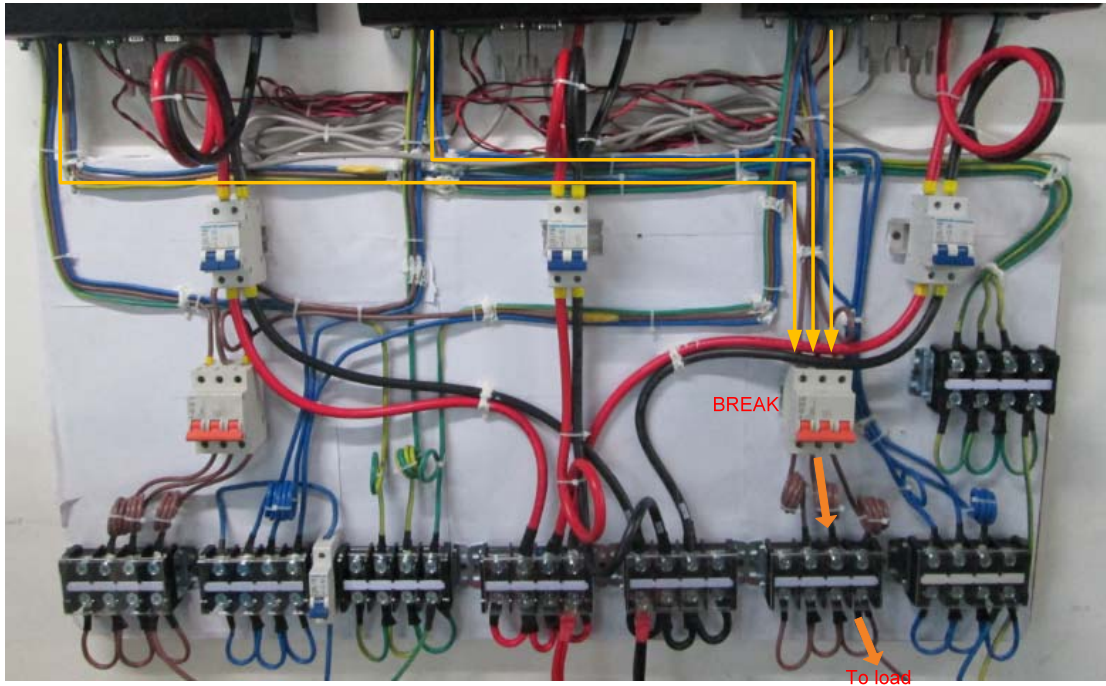

Refer to below figure for the connection of load output neutral cable.

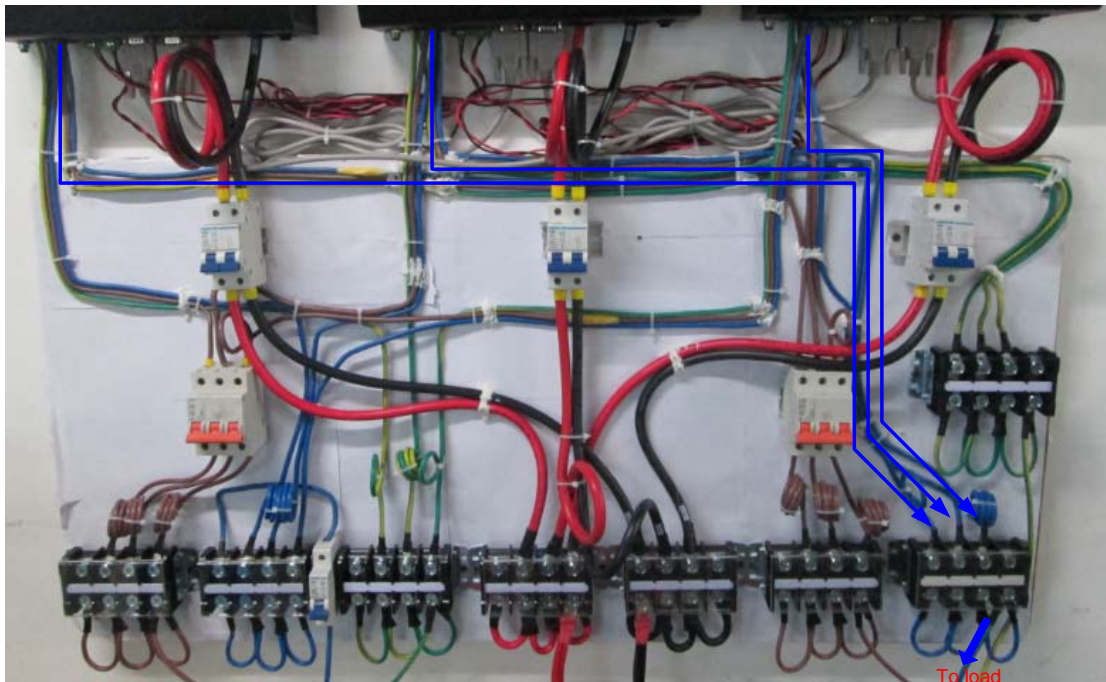

Refer to below figure for the connection of load output ground cable.

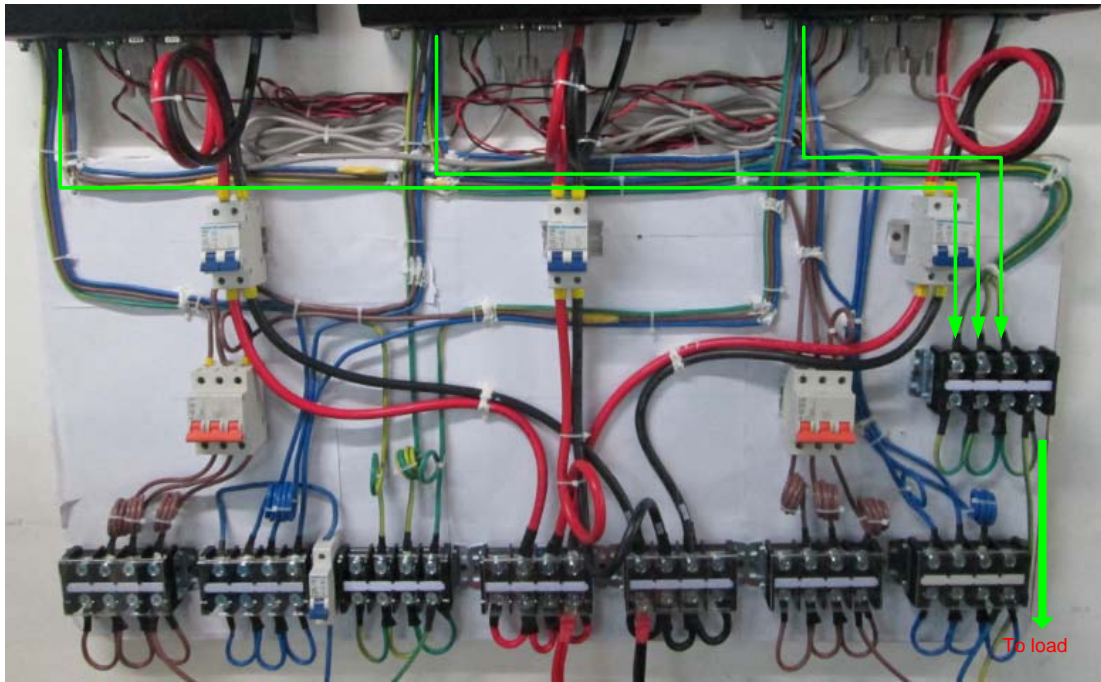

3.3 Battery cable connection

Refer to below figure for the connection of battery positive cable.

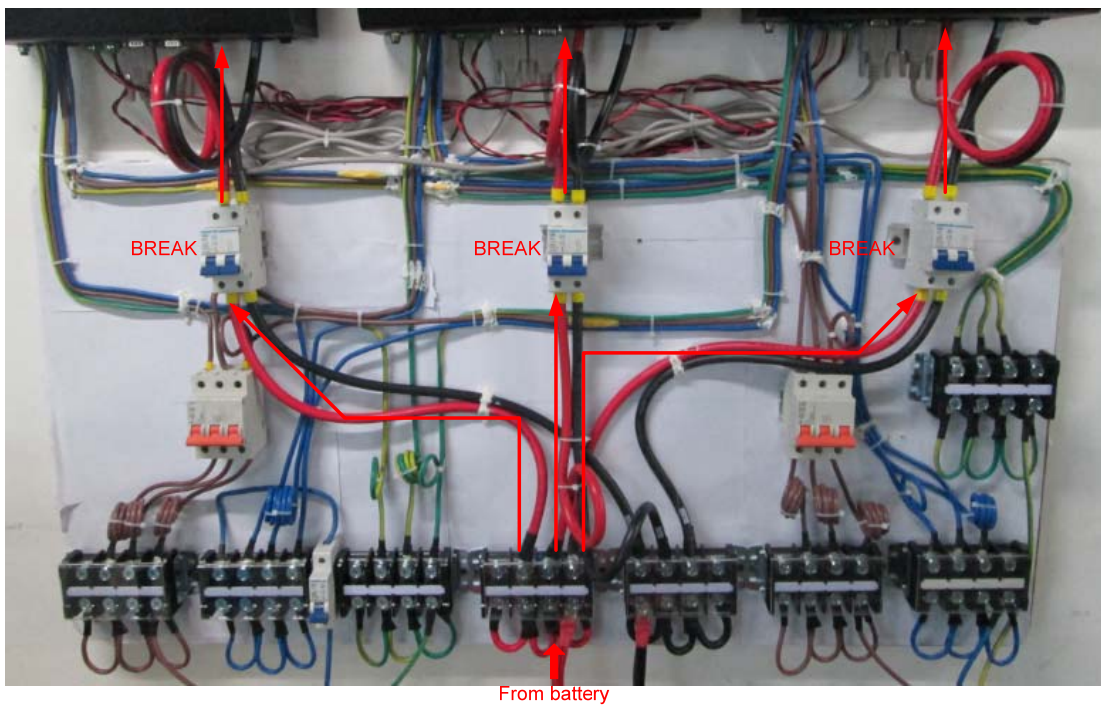

Refer to below figure for the connection of battery negative cable.

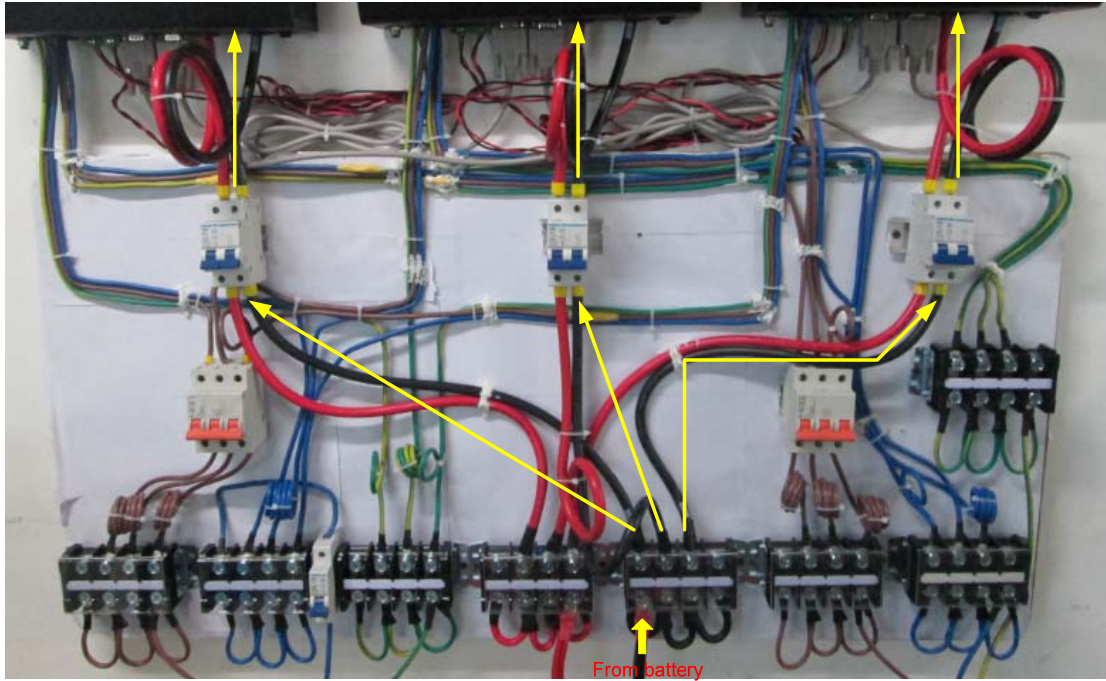

3.4 Communication connection

The communication cables are connected shown as below:

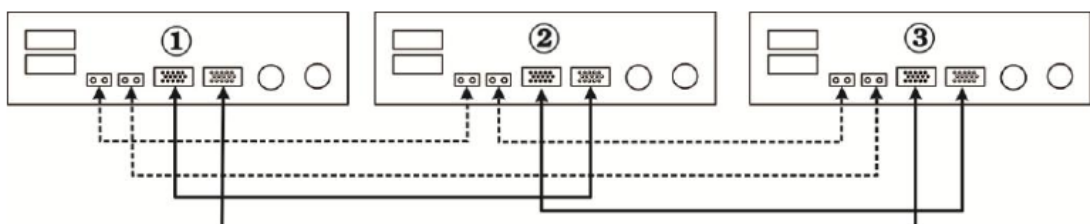

4. Commissioning

Warning: After the wiring connection, please be sure that all the breakers are off before starting up the system.

4.1 Parallel mode selecting

Warning: Before turn the system on; be sure that all the inverters had been set to "PAL" mode.

You can follow the steps as below to finish the setting.

Step1: Turn on the battery breaker of the inverter A.

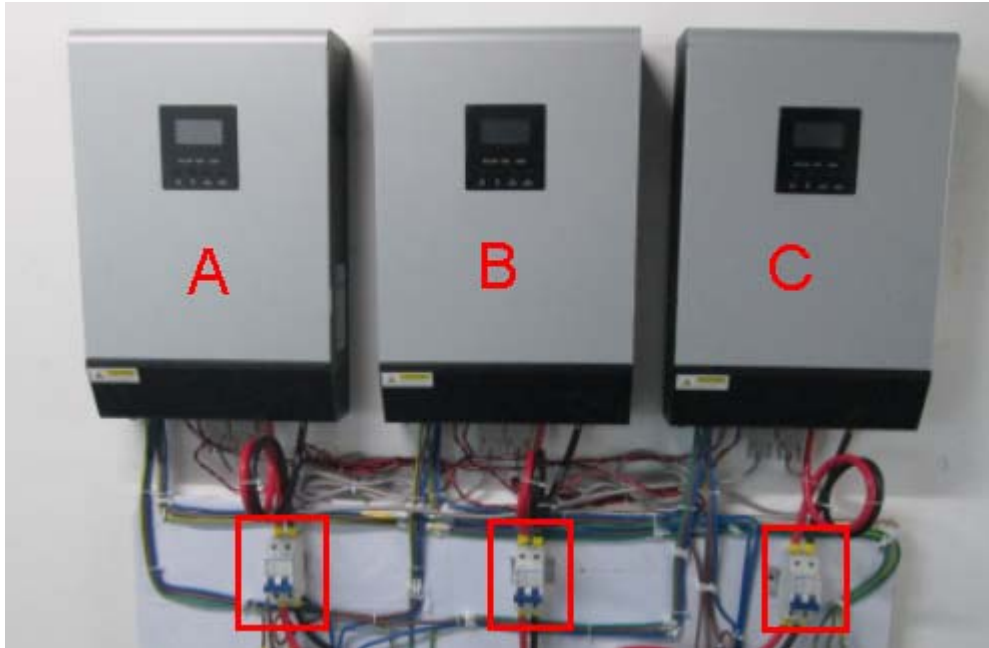

Warning: During mode setting, only one breaker can be turn on at the same time.

Step 2: Press the switch on, and the inverter A will start up and work in battery mode.

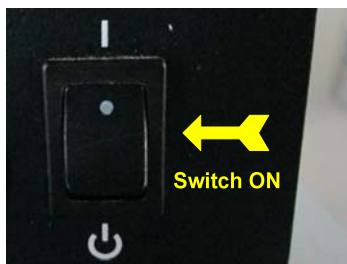

Step 3: Pressing and holding "ENTER" button for 3 seconds, the unit will enter setting mode. And Press "UP" or "DOWN" button to select setting programs #28, then press "ENTER" button to go into #28 menu, use "up" or "down" button and turn to "PAL".



Step 4: Before press "enter" button to select "PAL", turn the switch off, and then press "enter" button, "PAL" will be effective.

Note: The setting couldn't be taken effect until the inverter in standby mode. Switch off the inverter will let the inverter go into the standby mode.

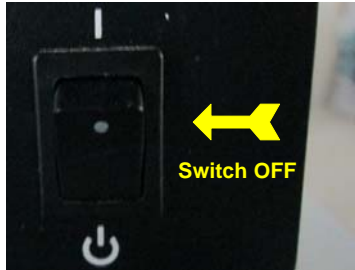

Step 5: After the setting successful, turn off the battery break.

Step 6: Please repeat step 1~5, and set inverter B and C to "PAL".

4.2 System start up

After finishing the setting, then you can start up the whole system by the following steps:

Step1: Ensure all the breakers are off before the power connected in.

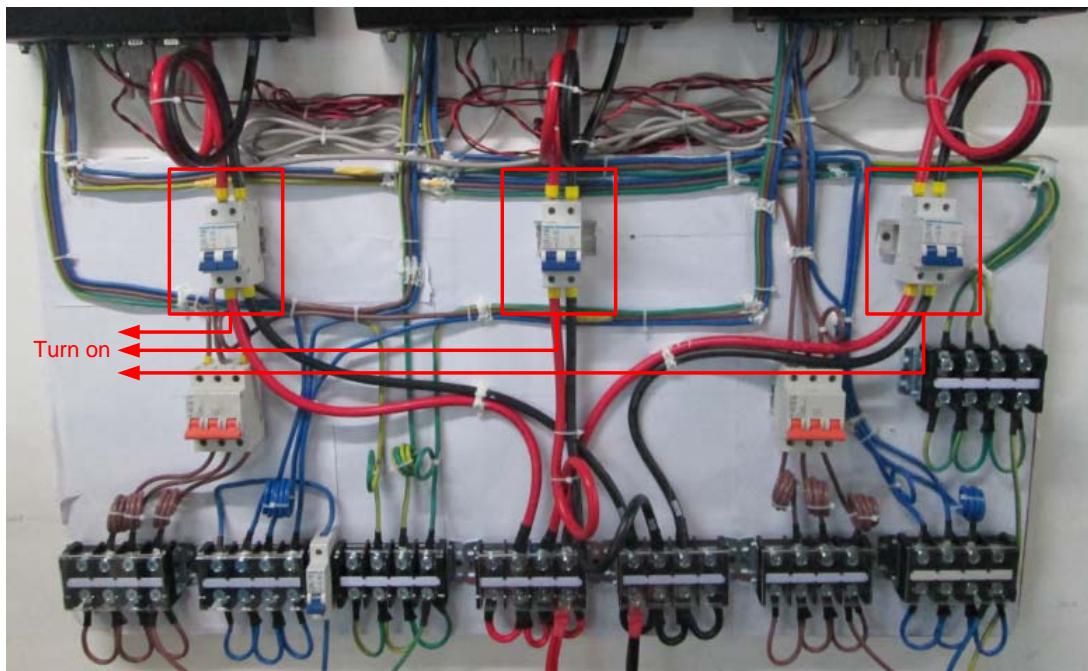

Step2: Turn on the battery breaker of each unit.

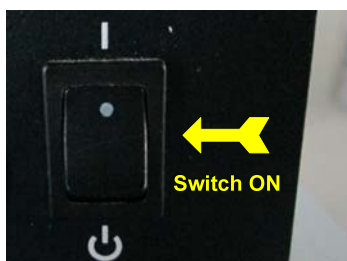

Step 3: Press the switch on of each unit.





Step 4: If the system is normal, the LCD of the inverter will be shown as below:

LCD display in Master unit	LCD display in Slave unit
	

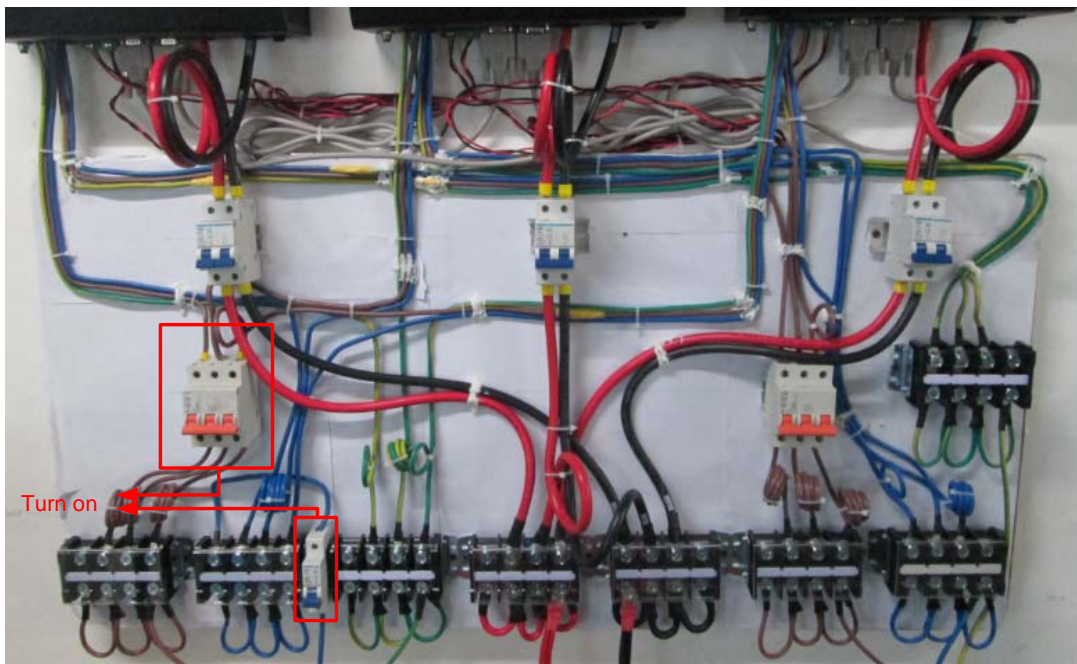
Step 5: Turn on the utility input breaker



Step 6: If the utility is OK, the inverter will turn to the line mode.

LCD display in Master unit	LCD display in Slave unit
	

Step 7: Turn on the load output breaker, and the parallel system can start to provide the power to the load.